

FrameWorks® System 2000



The Multi-Purpose Sign System for the 21st Century

Featuring the System 2000 with New Components

- ◆ **Advanced Features**
- ◆ **Easier to Use!**
- ◆ **New Applications**
- ◆ **More Durable!**
- ◆ **Enhanced Styling**
- ◆ **Eye-Catching!**
- ◆ **Sells More Product!**
- ◆ **Increases Profits!**

CLAMP-SWING  PRICING CO.

The FrameWorks® System 2000

CLAMP - SWING

2

PRICING COMPANY

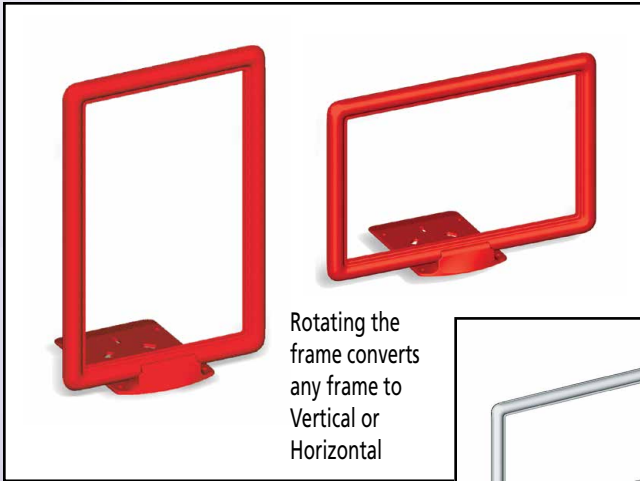

Rotating the frame converts any frame to Vertical or Horizontal

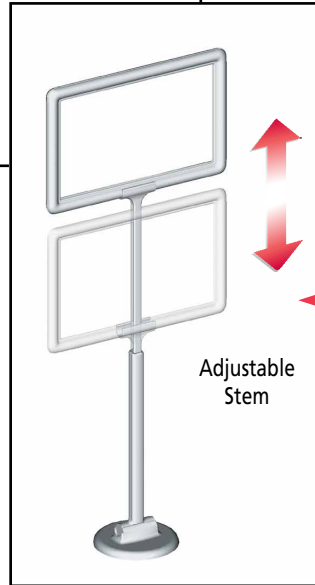

Adjustable Stem

The FrameWorks Sign System continues to be the highest quality product in the industry.

- Our System 2000 features snap-on adaptors, which are easy to use and provide additional versatility.
- A self-centering feature ensures that the new components will always present a finished look.
- The inner card slot has been widened for easier sign changes.
- An integral card retainer also functions as a spacer to enhance the appearance.
- The uniquely attractive frame doubles as either a horizontal or vertical sign holder.

▶ The **Models 2012 12"** and **2008 8"** Stems come pre-assembled and ready to use. The unique, patented design is fully adjustable from 12½" to 21½", or 7¼" to 11" in ½" increments. Simply pull up or push down until you reach the desired height. Fits all 2000 Series Bases.

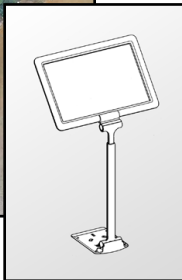

Model 2035 Angle Adaptor. Use to angle a low counter or in conjunction with the 2012 Stem at the top and/or bottom of the stem. Angles of 10°, 20° and 40° are pre-set with degree indicators engraved on the side of the part.

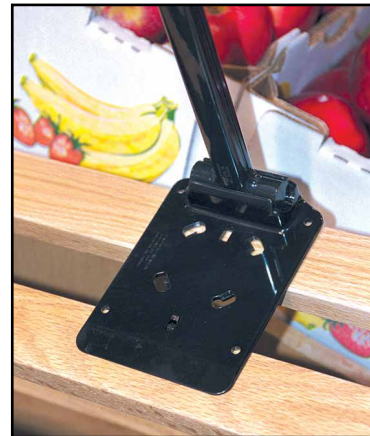

Model 2036 Euro Base fits all standard slat-type European tables. Use with the 2035 Angle Adaptor at the top for a typical display (See Page 4).



Model 2006 Counter Base is also available with magnets.



Model 2013 Easel Base for Counter or End Cap Displays.

Direct Mount Applications



Easel Base... For Any Stack Display



Model 2013
Easel with
Model 2035
Angle Adaptor;
Creates the
Perfect Viewing
Angle



Model 2006
Counter Base
with 2035
Angle Adaptor



Model 130 T-2, 2" x 4" T-Base with optional magnets;
Ideal for Meat Counters, Produce Tables and Coffin Freezers.



Model 129 T-5, 5" x 4" T-Base with original mounting
between the frame halves.



Counter Base; With or Without Magnets

Direct Mount Applications						
Card Size	Easel	Counter	Easel/Angle*	Counter/Angle*	T-5	T-2
3 1/2" x 5 1/2"	2FE35	2FC35	2FEA35	2FCA35	FTB35	FTN35
3 1/2" x 8"	2FE38	2FC38	2FEA38	2FCA38	FTB38	FTN38
3 1/2" x 11"	2FE311	2FC311	2FEA311	2FCA311	FTB311	FTN311
5 1/2" x 7"	2FE57	2FC57	2FEA57	2FCA57	FTB57	FTN57
7" x 11"	2FE711	2FC711	2FEA711	2FCA711	FTB711	FTN711
8 1/2" x 11"	2FE811	2FC811	2FEA811	2FCA811	FTB811	FTN811
11" x 14"	2FE114	2FC114	2FEA114	2FCA114	FTB114	FTN114

Note: 3 1/2" x 8" and 3 1/2" x 11" frames are special order.

*Includes one model 2035 angle adaptor

Adjustable Stem Models



Model 2013 Easel/Dump Base with optional **2038** Wire Rack Adaptor, (see page 6), ensures that the frame will not tip over, even if the case is empty.



Model 2038 Wire Rack Adaptor with **2013** Base attached to standard meat case shelf.



Model 2006 Counter Base; Magnets are optional.

CLAMP - SWING

4

P R I C I N G C O M P A N Y



Model 2036 Euro Base Adaptor with **2035** Angle Adaptor ensures a good viewing angle for slanted produce and bakery tables.

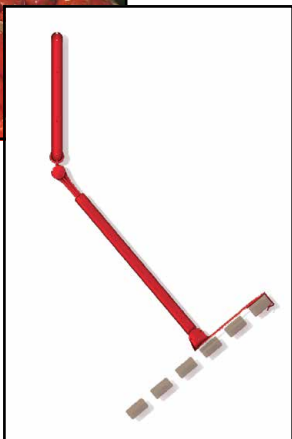

Series 2FLD comes with **Model 2036** Euro Base and **Model 2035** Angle Adaptor.



Models 2012 12" and **2008 8"** Adjustable Stems snap onto frames and bases quickly and are always centered. Use with any 2000 Series Base and 2035 Angle Adaptor.



Model 2006 Counter Base for free-standing displays such as Floral and Bakery Departments. Shown is Series 2FLC with Model 2035 Angle Adaptor.

Adjustable Stem Models with 12" Stems						
Card Size	Easel	Easel/Angle*	Counter	Counter/Angle*	Euro*	Wire Rack
3 1/2" x 5 1/2"	2FAD35	2FLD35	2FAC35	2FLC35	2FED35	2FWD35
3 1/2" x 8"	2FAD38	2FLD38	2FAC38	2FLC38	2FED38	2FWD38
3 1/2" x 11"	2FAD311	2FLD311	2FAC311	2FLC311	2FED311	2FWD311
5 1/2" x 7"	2FAD57	2FLD57	2FAC57	2FLC57	2FED57	2FWD57
7" x 11"	2FAD711	2FLD711	2FAC711	2FLC711	2FED711	2FWD711
8 1/2" x 11"	2FAD811	2FLD811	2FAC811	2FLC811	2FED811	2FWD811
11" x 14"	2FAD114	2FLD114	2FAC114	2FLC114	2FED114	2FWD114

Note: 3 1/2" x 8" and 3 1/2" x 11" frames are special order.

*Includes one Model 2035 Angle Adaptor

Shelf Moulding



Model 120 Patented, Flexible Side-View Assembly is unbreakable.



Ideal for Private Label Promotions.



The clamp design enables the frame to be rotated to the best viewing angle. Shown with optional Carriage Bolt, Washer and Wing Nut for more secure assembly.

Shelf Moulding			
Card Size	Side-View	Front-View	Front-View /Angle*
3 1/2" x 5 1/2"	FFS35	FFC35	FFA35
3 1/2" x 8"	FFS38	FFC38	FFA38
3 1/2" x 11"	FFS311	FFC311	FFA311
5 1/2" x 7"	FFS57	FFC57	FFA57
7" x 11"	FFS711	FFC711	FFA711
8 1/2" x 11"	FFS811	FFC811	FFA811
11" x 14"	N/A**	FFC114	FFA114

Note: 3 1/2" x 8" and 3 1/2" x 11" frames are special order.

* Includes one Model 2035 Angle Adaptor.

** Not recommended with standard hinge. Custom hinge available on special order only.



Model 2037 Front-View Adaptor snaps onto frame for standard shelf display.

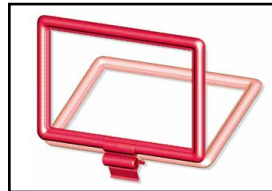

Model 2035 Angle Adaptor adjusts to 3 positions for best viewing; 10°, 20° or 40°.



Add a **Model 2035** Angle Adaptor to sign slanted shelves or angled coffin case mouldings.

Hanging Models



Front Hangers, **Model 126**, for Canopies or Wire



No. 126 HC Front Hanger

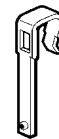

No. 114 HW Back Hanger

Hanging Models		
Card Size	Back Hanger (Wire)	Front Hanger (Canopy)
3 1/2" x 5 1/2"	FHW35	FHC35
3 1/2" x 8"	FHW38	FHC38
3 1/2" x 11"	FHW311	FHC311
5 1/2" x 7"	FHW57	FHC57
7" x 11"	FHW711	FHC711
8 1/2" x 11"	FHW811	FHC811
11" x 14"	FHW114	FHC114

Note: 3 1/2" x 8" and 3 1/2" x 11" frames are special order.

Special Adaptors

CLAMP - SWING

6

P R I C I N G C O M P A N Y



The Patented **Model 2038** Wire Rack Adaptor, when used with 2013 Dump Base, eliminates the common problem of sign holders falling over when a display sells-down. It attaches to the base in either of two positions which enables it to connect to wire shelves running either parallel or perpendicular to the case.

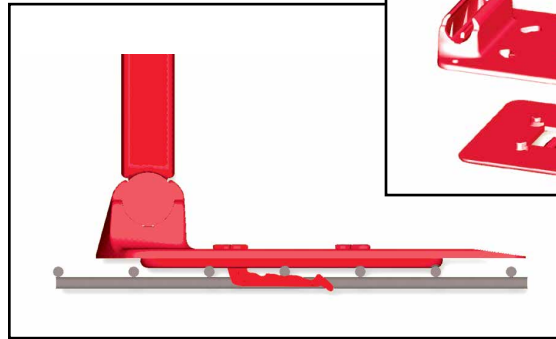

The Wire Rack Adaptor fits all standard racks with wire diameters from 1/8" up to 3/16". Quickly installed or removed, provides the stability to keep the unit upright.



Model 2035 Angle Adaptor adjusts to 3 positions for best viewing; 10°, 20° or 40°.



The Angle Adaptor mounts at the top and/or bottom of a stem model for maximum flexibility. Ideal for Floral and Produce Departments.

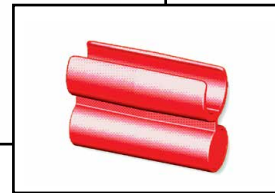

Model 2035
Detail



Model 2042
Detail

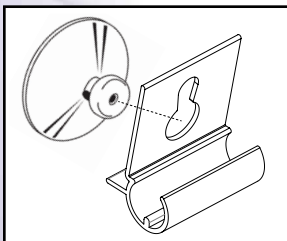

Model 2042 Suction Cup Adaptor is sold in pairs with the cups attached. It's the perfect solution for signing glass doors. The patent pending design keeps the frames snug against the glass.

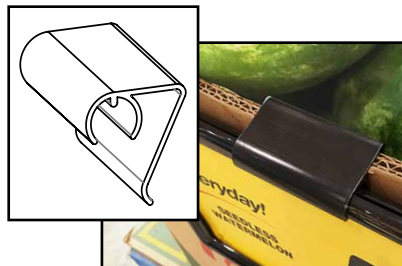

Model 2043 Bulk Bin Adaptor fits most standard double or triple wall corrugated display bins. Use indoors or outdoors for mass displays.



Model 115 Perfboard/SlatWall Adaptor is used with Model 122 Wall Mount Bracket.

Special Adaptors				
Card Size	Bulk Bin	Perf Board/ Slatwall	Wall Mount	Suction Cup
3 1/2" x 5 1/2"	FBB35	FPB35	FW35	FSC35
3 1/2" x 8"	FBB38	FPB38	FW38	FSC38
3 1/2" x 11"	FBB311	FPB311	FW311	FSC311
5 1/2" x 7"	FBB57	FPB57	FW57	FSC57
7" x 11"	FBB711	FPB711	FW711	FSC711
8 1/2" x 11"	FBB811	FPB811	FW811	FSC811
11" x 14"	FBB114	FPB114	FW114	FSC114

Note: 3 1/2" x 8" and 3 1/2" x 11" frames are special order.

Other Sign Holder Products



Model VAS8-BK 8" Adjustable Stem accepts View-Lok® Clear Card Holders for paper signs and Just Pic'd™ or custom track systems for Folded Panels. Use with **Model 2006** or **2013** Bases. Black only.

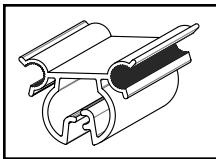

Model VASA-BK converts **Model 2012** 12" stem to accept View-Lok® Holders

Model 2040

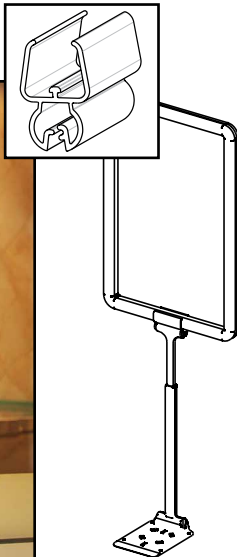
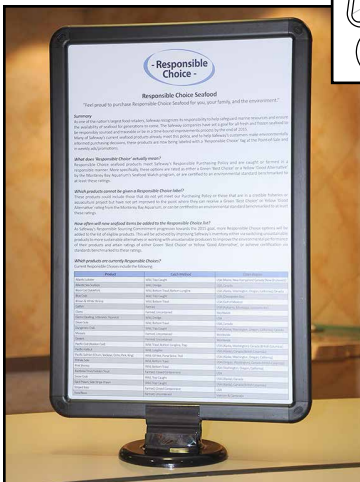

Model 2040 Sectional Frame Adaptor attaches to our FrameWorks Bases or to the top of our **2012** Adjustable Stem. Shown with an 11" x 17" sign. Sectional Frames can be made in any size on a custom basis only and can also be hung or wall mounted.



Model FMSH228-1 is a Bulletin Floor Model Sign Holder for 22" x 28" ads and promotions. Made from 1" steel tubing in a black finish with leveling feet. Shipped knocked down, requires assembly. Other styles are available.

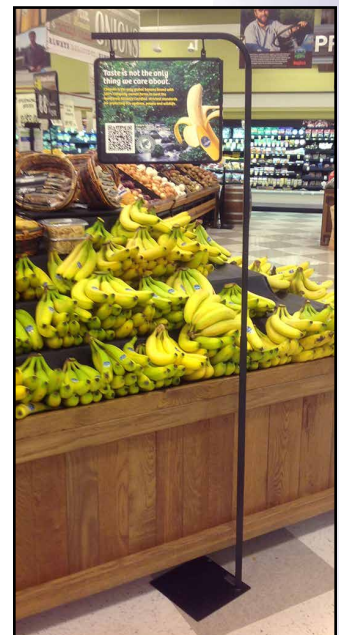

Model FMH114-1-72A for signing tables or pallet displays. Shown with a metal frame to hold 11" x 14" signs. Made from square steel tubing, powder coated black, adjustable from 48" to 72". Other frame sizes are available.



Chalk Board Sign Blanks are available for all standard frame sizes in packages of 20.

Our custom plastic toppers feature a unique design that snaps into 7" x 11" or 8 1/2" x 11" frames.



Easier to use and less expensive than traditional sign inserts that fill the entire frame. Let us quote your next topper project.

The FrameWorks System... Order Information

Size Codes			
Card Sizes	Model	Card Sizes	Model
3 1/2" x 5 1/2"	F35	7" x 11"	F711
3 1/2" x 8"	F38	8 1/2" x 11"	F811
3 1/2" x 11"	F311	11" x 14"	F114
5 1/2" x 7"	F57		

Color Codes	
Color	Code #
Black	- 1
Red	- 3
White	- 6

3 1/2" x 8" and 3 1/2" x 11" are special order only.
Availability of colors and sizes subject to change.

Specify Number

Versatile... With Frames and Adaptors to Fit Any Situation

Components

Frames

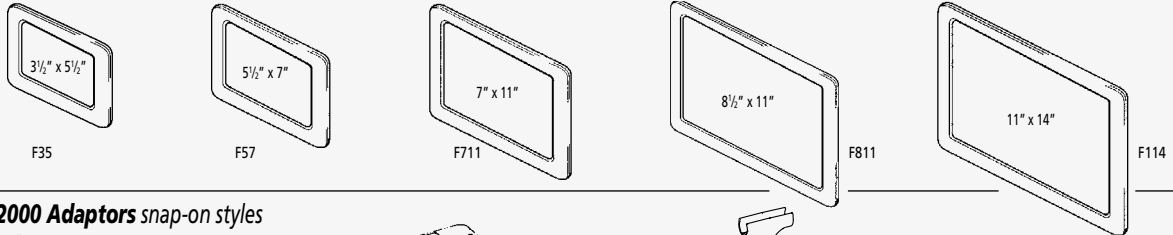

System 2000 Adaptors snap-on styles

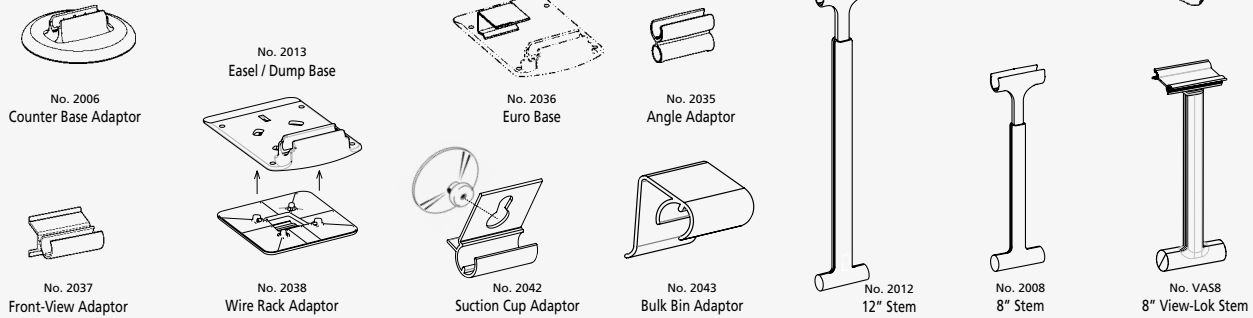

Primary Adaptors for original mounting between the frame halves

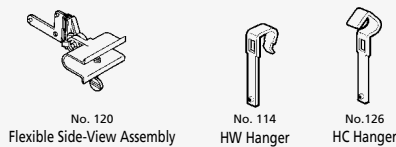

Secondary Adaptors

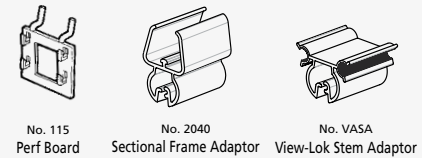

FrameWorks Order Information:

Minimum Order \$50.00
All Prices F.O.B. Oakland, CA

FrameWork Sign Holders: Complete with components shown - 20 per case. Broken case prices will apply to all quantities not packed in 20-unit increments. All FrameWorks are priced unassembled. Assembled and welded frames will be set up in a horizontal orientation unless vertical is specified.

Unassembled: All components are shipped in their own cartons of 20 or Master Cases depending upon the quantities being ordered. For convenience, we may elect to pack the smaller items in the box with the frames. Special Kit Packing to your specifications may incur an extra charge.

Standard Assembly: With System 2000 Components, only the part that connects to the frame will be attached. With Original Components, only the Primary Adaptor is inserted between the frame halves. In all cases, Secondary Adaptors, if any are required, are attached by the customer.

Full Assembly: Except for the bases, which pack separately, all components, including screws, are assembled. Models 2036 Euro Base Adaptors and 2038 Wire Rack Adaptors are not attached to the bases.

Welded: FrameWorks may be welded. The Primary Adaptor can never be changed or relocated!

Custom Assembly and Packaging: Available on a quotation basis.



8386 Capwell Drive • Oakland, CA 94621

V: (510) 567-1600 Toll Free: 800-227-7615 F: (510) 567-1830
e: sales@clampswing.com WEB: www.clampswing.com

©2017 Clamp-Swing Pricing Company

Patented, See: www.clampswing.com
Other Patents Pending